

## Uniones

### Unión bridada

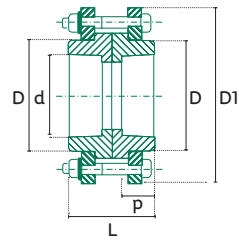

Código	d	D	p	L	D1	Peso
200238	40	53	22	53	96	752
200238	50	67	25	60	108	780
200238	63	84	28	66	138	1079
200238	75	100	30	80	160	2800
200238	90	122	33	90	180	3200
200238	110	138	43	112	200	3800

### Unión bridada mixta

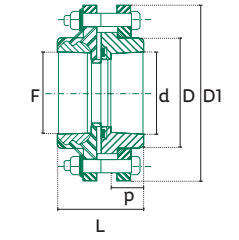

Código	d	F	D	p	L	D1	Peso
200249	40	x	1 1/4	53	22	60	96
200244	50	x	1 1/2	67	25	64	108
200245	63	x	2	84	28	67	138
200246	75	x	2 1/2	100	30	76	160
200247	90	x	3	122	33	78	180
200248	110	x	4	138	43	98	200

### Tapón

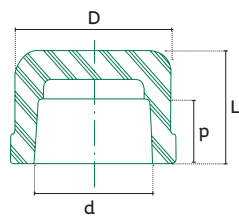
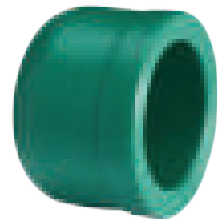

Código	d	D	p	L	Peso
200155	20	30	16	20	9
200156	25	33	18	23	12
200157	32	42	20	26	20
200158	40	52	22	30	41
200159	50	66	27	35	75
200160	63	83	32	42	142
200161	75	100	29	60	250
200162	90	120	33	68	391
200154	110	145	41	75	560

### Montura de derivación o sileta

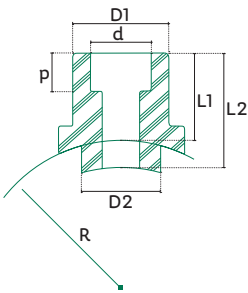

Código	Tubo	d	D1	D2	p	R	L1	L2
200121	63	20	28	25	16	32	28	37
200123	75	20	28	25	16	38	28	39
200126	90	20	28	25	16	45	28	41
200117	110	20	28	25	16	55	28	45
200122	63	25	34	25	18	32	31	39
200124	75	25	34	25	18	38	31	42
200127	90	25	34	25	18	45	30	43
200118	110	25	34	25	18	55	30	47
200125	75	32	43	33	20	38	34	46
200128	90	32	43	33	20	45	34	48
200119	110	32	43	33	20	45	34	51

Referencias: peso de las conexiones en gramos; dimensiones en mm.

## Válvulas

### Válvulas Esfera PP-R

Código	d	D	p	a	L	L1	Peso
200360	20	29	18	15	77	45	0.11
200361	25	36	18	18	79	49	0.16
200362	32	44	20	23	88	57	0.25
200363	40	55	21	32	103	65	0.41
200364	50	69	23	38	115	80	0.79
200365	63	87	27	42	132	82	1.19
200366	75	95	32	47	165	97	1.78
200367	90	113	35	56	185	113	2.71
200368	110	138	41	68	220	123	4.37

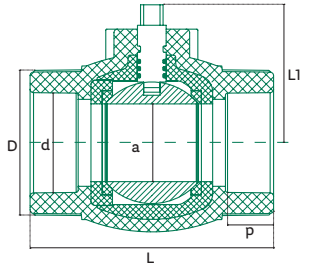

### Válvulas Globo PP-R

Código	d	D	p	a	L	L1	Peso
200369	20	28	16	13	67	74	0.15
200370	25	34	17	17	78	81	0.24
200371	32	43	20	17	80	84	0.26
200372	40	52	22	21	95	95	0.41
200373	50	66	25	26	111	114	0.62
200374	63	82	26	31	121	121	0.86

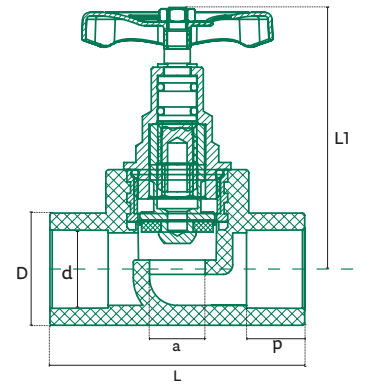

### Llave de empotrar para regadera

Código	d	D1	D2	p	L	L1	L2	Peso
210136	20	27	38	16	95	35	64	155

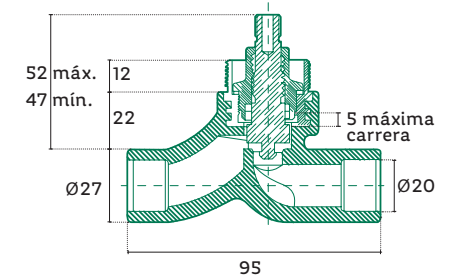
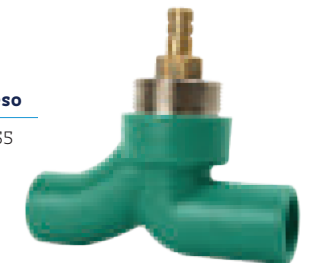

### Válvula Esfera

Código	d	D	p	L	L1	Peso
200250	20	37	16	96	94	55
200251	25	42	18	96	94	49

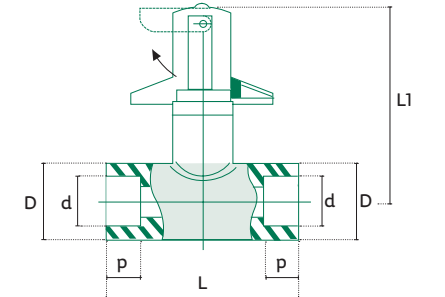

Referencias: peso de las conexiones en gramos; dimensiones en mm.